

RAMP REQUIREMENTS

1. Ramps serving dwellings shall be a minimum of 36" clear width. Commercial ramps shall be a minimum of 48" in clear width.
2. The surface slope of the ramp shall not exceed a slope of 1' in 12'
3. The top landing shall be a minimum of 60" x 60".
4. Bottom landings shall be a minimum of 72" long in the ramp direction and shall be at least as wide as the ramp.
5. Intermediate landings shall be at least 60" long in the ramp direction.
6. Intermediate landings which change the direction of the ramp shall be at least 60" x 60".
7. Surface of the ramp shall be roughened or constructed of slip-resistant material.
8. Ramps and landings which have drop-offs or ramps exceeding 10' in length and not bounded by a wall or fence, shall have edge protection consisting of either a guide curb a minimum of 2" in height or a wheel guide rail centered 3" plus or minus 1" on each side of the ramp. (NOTE: When a drop-off exceeds 4" in height, the guide curb must be increased to project a minimum of 6" above the ramp and landing surfaces.

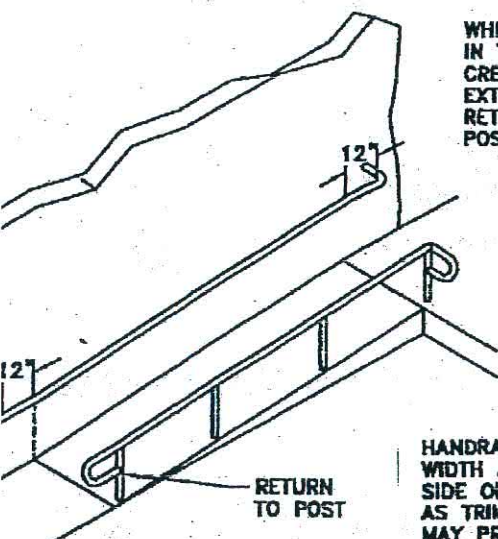

WHERE THE EXTENSION OF THE HANDRAIL IN THE DIRECTION OF THE RAMP RUN WOULD CREATE A HAZARD, THE TERMINATION OF THE EXTENSION MAY BE MADE ROUNDED OR RETURNED SMOOTHLY TO A FLOOR, WALL OR POST

NOTE: HANDRAILS MUST EXTEND A MINIMUM OF 12" OF LEVEL DISTANCE (PARALLEL TO LANDING SURFACE) BEYOND TOP AND BOTTOM OF THE RAMP ENDS BEFORE THEY ARE RETURNED

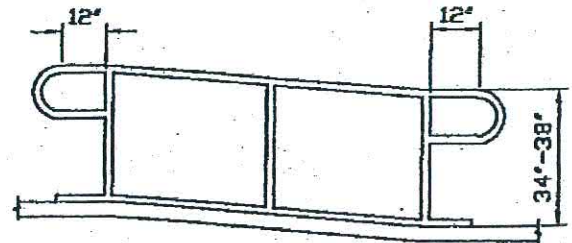

HANDRAILS MAY PROJECT INTO THE REQUIRED WIDTH A DISTANCE OF 3-1/2" FROM EACH SIDE OF A RAMP. OTHER PROJECTIONS, SUCH AS TRIM AND SIMILAR DECORATIVE FEATURES, MAY PROJECT INTO THE REQUIRED WIDTH 1-1/2" ON EACH SIDE

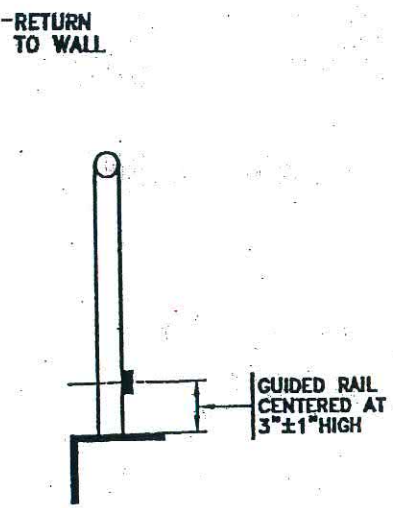

GUIDE RAIL DETAIL



NOTE: IF A DROP-OFF OF MORE THAN 4 INCHES EXISTS BETWEEN THE RAMP SURFACE AND THE ADJACENT GRADE, A 6 INCH WARNING CURB MUST BE UTILIZED.

WARNING CURB EDGE PROTECTION

NOTE 1: WHEN DOOR SWINGS ONTO LANDING - 42" MIN. PLUS DOOR WIDTH
NOTE 2: MAXIMUM HORIZONTAL DISTANCE OF EACH RAMP AND RUN VARY

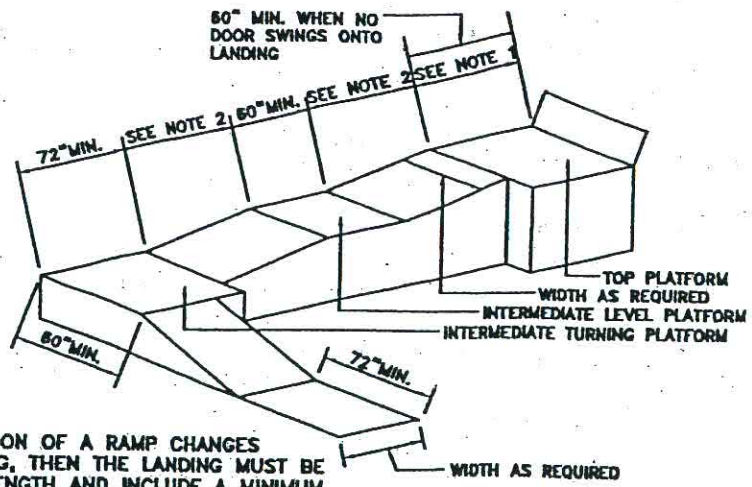

NOTE: WHEN THE DIRECTION OF A RAMP CHANGES 30° OR MORE AT LANDING, THEN THE LANDING MUST BE A MINIMUM OF 72" IN LENGTH AND INCLUDE A MINIMUM 60"x 60" TURNING PLATFORM

RAMP WITH TURNING PLATFORM

(WHEN DIRECTION OF RAMP CHANGES 30 DEGREES OR MORE)

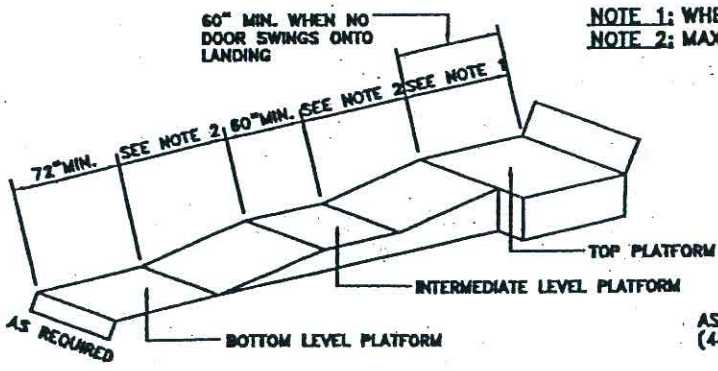

NOTE 1: WHEN DOOR SWINGS ONTO LANDING - 42" MIN. PLUS DOOR WIDTH
NOTE 2: MAXIMUM HORIZONTAL DISTANCE OF EACH RAMP AND RUN VARY

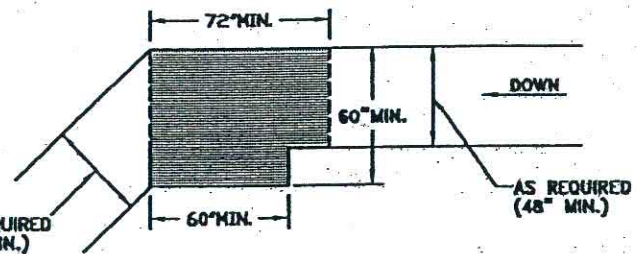

30 DEGREE OR GREATER ANGLE

STRAIGHT RAMP RUN

NOTE 1: WHEN DOOR SWINGS ONTO LANDING - 42" MIN. PLUS DOOR WIDTH.
NOTE 2: MAXIMUM HORIZONTAL DISTANCES OF EACH RAMP AND RUN VARY.

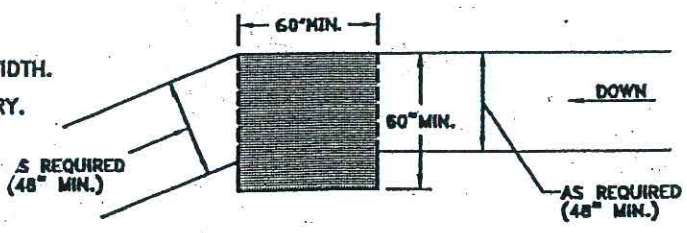
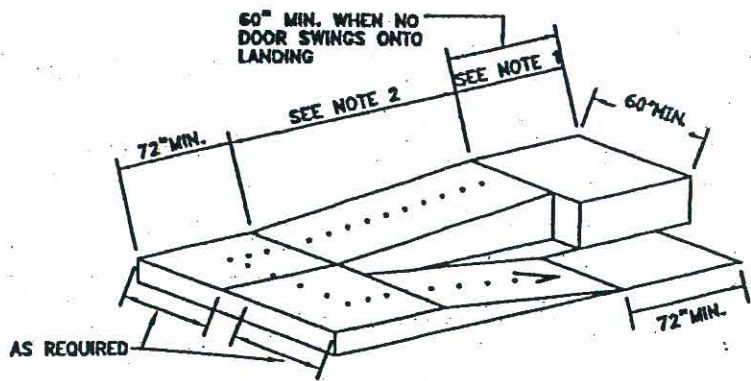

LESS THAN 30 DEGREE ANGLE

RAMP WITH INTERMEDIATE SWITCH-BACK PLATFORM

SHADED AREA REPRESENTS REQUIRED LEVEL (2% OR LESS) LANDING AREA DIMENSIONS WHEN A RAMP CHANGES DIRECTION AT A LANDING